

### **Contents**

- A Your Meters Feature
- B Specifications
- C Making Measurements
- D Maintenance
- E Accessories
- F Using Holster
- G Using Strap











### **Introduction**

One kind of UNI-T brand new UT50 series Multimeters is a 3 1/2 digit with steady function and highly reliable hand-held measuring instrument. The Meter uses large scale of integrated circuit with double integrated A/D converter as its core and has full range overload protection. The Meter can measure DC current, AC current, DC Voltage, AC Voltage, Resistance, Capacitance, Diode, Temperature, Frequency and Continuity, which is an ideal tool for users.

## Safety Rules

- 1 The UNI-T UT50 series comply with IEC 61010: in pollution degree 2, overvoltage category (CAT I 1000V and CAT II 600V) and double insulation. Use the Meter only as specified in this manual, otherwise the protection provided by the Meter may be impaired.
- 1 CAT I-For signal level, telecommunication, electronic with small transient over voltage.
- 1 CAT II -For local level, appliances, main wall outlets, portable equipment.
- 1 The meter is designed to withstand the stated Max. voltages. If it's not possible to exclude without doubts that impulses, transients, disturbance or for other reasons, these voltages are exceeded a suitable prescale (10:1) must be used.
- 1 Do not operate the Meter before the cabinet has been closed and screwed safely as terminal can carry voltage.
- 1 Make sure before each measurement the Meter is set to the suitable range.
- 1 Before using the Meter, please inspect the cabinet and test leads for damaged insulation or exposed metal.
- 1 Connect the red and black test lead to the correct measuring input jack properly.
- 1 Do not input values over the maximum range of each measurement to avoid damages of the Meter.
- 1 Do not turn the rotary function switch during Voltage and Current measurement, otherwise the Meter could be destroyed.

- 1 **Make sure to use new fuses with proper rating in stead of bad fuses .**
- 1 **To avoid electric shock or damages, do not apply more than 1000V between the "COM" terminals and"  $\perp$  "earth ground.**
- 1 **Use caution when working with Voltages above 60V (DC) or 30Vrms (AC). These Voltages pose shock hazard.**
- 1 **Replace the battery as soon as the battery indicator "  " appears. With a low battery, the Meter might produce false readings that can lead to electric shock and personal injury.**
- 1 **Turn off the Meter once finished measuring, fetch out the battery, when the meter will not be used for long period.**
- 1 **Do not operate the Meter under adverse environmental condition especially humid area.**
- 1 **To avoid damages and dangerous, do not change the circuit.**
- 1 **Periodically wipe the case with a damp cloth and mild detergent. Do not use abrasives or solvents.**
- 1 **The Meter is suitable for indoor use only.**
- 1 **International Electrical Symbols:**

	Low Battery		Earth Ground
	Safety Rules		Double Insulated
	AC		Diode
	DC		Buzzer
	Fuse		
	Dangerous Voltages		

## A. Your Meters Feature

- 1 **32 ranges.**
- 1 **Liquid Crystal Display, digits height is 27mm.**
- 1 **Overload display I.**
- 1 **Maximum display 1999 (3 1/2 digit).**
- 1 **Full range overload protection.**
- 1 **Auto-Power Off (For UT53, UT54 and UT55 ONLY).**
- 1 **Temperature:**
  - Operating: 0°C to 40°C (32 °F to 104 °F).**
  - Storing: -10°C to 50°C (14 °F to 122 °F ).**
- 1 **Altitude:**
  - Operating: 2000m**
  - Storing: 10000m.**
- 1 **Relative Humidity: Max. relative humidity 80% for temperature up to 31°C decreasing linearly to 50% relative humidity at 40°C.**
- 1 **Low Battery display " 𐀀 " .**
- 1 **Battery Type: 9V NEDA 1604 or 6F22 or 006P**
- 1 **Strap for easy carry.**
- 1 **Tilt stand design, three observation angles, is in favor of reading display.**
- 1 **Dimension: 190mm x 88mm x 34mm.**
- 1 **Weight: Meter only(excluding test leads) about 270g .Meter + holster + tilt stand about 550g.**

### B. Specifications

Accuracy is specified for one year after calibration, at operating temperatures 23°C +/- 5°C, with relative humidity at < 75%. Accuracy specifications take the form of: +/- (a% readings + digits )

#### B-1 Direct Current Voltage (DC Voltage)

Range	Resolution	Accuracy				
		UT51	UT 52	UT53	UT54	UT55
200mV	100µV	± (0.5% +1)				
2V	1mV					
20V	10mV					
200V	100mV					
1000V	1V	± (0.8% +2)				

⚠ Input impedance: All ranges are 10MΩ .  
 Overload protection: 200mV is 250VDC or AC RMS. All other ranges is 750Vrms or 1000Vp-p.

#### B-2 Alternating Current Voltage (AC Voltage)

Range	Resolution	Accuracy				
		UT51	UT 52	UT53	UT54	UT55
200mV	100µV	±(1.2% +3)		---	---	
2V	1mV	±(0.8% +3)				
20V	10mV					
200V	100mV					
750V	1V	±(1.2% +3)				

⚠ Input impedance: All ranges are 10MΩ.  
 Frequency: 40Hz-400Hz .  
 Overload protection: 200mV is 250VDC or AC RMS. All other ranges is 750Vrms or 1000Vp-p.  
 Display: Average Value (RMS of Sine Wave).

## B-3 Direct Current Current (DC Current)

Range	Resolution	Accuracy				
		UT51	UT 52	UT53	UT54	UT55
20μA	0.01μA	±(2%+5)	---			
200μA	0.1 μA	±(0.8%+1)	---			
2mA	1 μA	±(0.8%+1)				
20mA	10μA					
200mA	100 μA	±(1.5%+1)				
2A	1mA	±(1.5%+1)	---			
10A	10mA	±(2%+5)	---			
20A		---	±(2%+5)			

 Overload protection:

**For UT51:**

2A, 250V fast acting fuse, φ5x20mm(below 2A range)

10A, 250V fast acting fuse, φ5x20mm(at 10A range) .

**For UT52/53/54/55:**

315mA, 250V fast acting fuse, φ5x20mm (No fuse at 20A range).

Max current input :

**For UT51:** 10A (The measurement time for high current should be less than 10 seconds maximum, and the interval time between two measurements should be greater than 15 minutes.

**For UT52/53/54/55:** 20A (The measurement time for high current should be less than 15 seconds maximum, and the interval time between two measurements should be greater than 15 minutes.

## B-4 Alternating Current Current (AC Current)

Range	Resolution	Accuracy				
		UT51	UT 52	UT53	UT54	UT55
200μA	0.1μA	±(1.8%+3)	---			
2mA	1μA	±(1%+3)		---		
20mA	10μA	±(1%+3)				
200mA	100 μA	±(1.8%+3)				
2A	1mA	±(1.8%+3)	---			
10A	10mA	±(3%+7)		---		
20A		---	±(3%+7)			

**!** Overload protection:

**For UT51:**

2A, 250V fast acting fuse, φ5x20mm(below 2A range)

10A, 250V fast acting fuse, φ5x20mm(at 10A range) .

**For UT52/53/54/55:**

315mA, 250V fast acting fuse, φ5x20mm (No fuse at 20A range).

Max current input :

**For UT51:** 10A (The measurement time for high current should be less than 10 seconds maximum, and the interval time between two measurements should be greater than 15 minutes.

**For UT52/53/54/55:** 20A (The measurement time for high current should be less than 15 seconds maximum, and the interval time between two measurements should be greater than 15 minutes.

Measuring voltage drop: Full range is 200mV.

Display: Average Value (RMS of Sine Wave) .

## B-5 Resistance

Range	Resolution	Accuracy				
		UT51	UT 52	UT53	UT54	UT55
200Ω	0.1Ω	±(0.8% +3)				
2KΩ	1Ω	±(0.8% +1)				
20KΩ	10Ω					
200KΩ	100Ω					
2MΩ	1KΩ					
20MΩ	10KΩ	±(1% +2)				
200MΩ	100KΩ	±[5%(-10) +10]				

⚠ Voltage at open circuit: 700mV (200MΩ range, open circuit voltage around 3V) .

Overload protection: All ranges 250VDC or AC RMS .

Caution: At 200MΩ range, as test lead is short circuit the LCD display 10 digits is normal, deduct the 10 digits from the measured reading during measuring.

## B-6 Capacitance

Range	Resolution	Accuracy				
		UT51	UT 52	UT53	UT54	UT55
2nF	1pF	---	±(4% +3)			
20nF	10pF					
200nF	100pF					
2μF	1nF					
20μF	10nF					

⚠ Testing signal: around 400Hz 40mVrms

## B-7 Frequency

Range	Resolution	Accuracy				
		UT51	UT52	UT53	UT54	UT55
2kHz	1Hz	---			±(2%+5)	---
20kHz	10Hz				±(1.5%+5)	



**⚠ Input sensitivity:  $\leq 100\text{mVrms}$ .**  
**Overload protection:  $250\text{Vrms}$ .**

## B-8 Temperature

Range		Resolution	Accuracy		
			UT51,52,53	UT53	UT55
-20°C to 1000°C	-20°C to 0°C	1°C	---	$\pm(5\%+3)$	
	0°C to 400°C			$\pm(1\%+3)$	
	400°C to 1000°C			$\pm 2\%$	

## B-9 Diode Test and Continuity Beeper

Range	Comment	Measuring Condition
→	Display diode forward-voltage near value, Unit "mV"	Forward DC current abt 1mA Backward DC voltage abt 2.8V
•••)	Beeper sounds if Continuity Resistance $\leq 70\Omega$ . Display near value. Unit "Ω"	Voltage at open circuit abt 2.8V



**⚠ Overload protection: 250V DC or AC RMS.**

## B-10 Transistor hFE test

Range	Comment	Measuring Condition
hFE	Can measure NPN or PNP transistor hFE. Range: 0-1000β	Basic polarity current abt 10μA, Vce abt 2.8V

## C. Making Measurements

### Caution:

- (1) If there is no display or “” is shown on the LCD when the Meter is switched on, replace the battery ASAP.
- (2) Never exceed the maximum input voltage or current limits shown besides the input jacks “”, otherwise the Meter will be damaged and this is dangerous to life.
- (3) Turn the rotary switch to proper range before operating.

- |                          |                    |
|--------------------------|--------------------|
| ① On/Off Switch          | ② Capacitance jack |
| ③ Liquid Crystal Display | ④ Temperature jack |
| ⑤ Rotary switch          | ⑥ Transistor jack  |
| ⑦ Input jack             |                    |

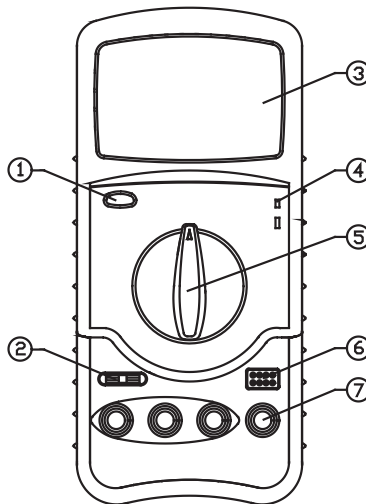

### C-1 Measuring DC Voltage

1. Connect the black test lead to “COM” jack and red test lead to “V” jack.
2. Set the rotary switch to “ $\text{V}$ ”.
3. Connect the test leads across with the object to be measured. LCD appears the measuring value and also the polarity of the red test lead.

#### Caution

- 1) If magnitude of the voltage is unknown, always start with the highest range and reduce until satisfactory reading is obtained.
- 2) If “1” is shown on the LCD, which means the Meter is overloaded, then set the measuring range to higher.
- 3) “” means never exceed the maximum input limits 1000V, otherwise internal circuit of the Meter will be damaged.
- 4) Take extra care of voltage leakage when measuring high voltage.

### C-2 Measuring AC Voltage

1. Connect the black test lead to “COM” jack and red test lead to “V” jack .
2. Set the rotary switch to “ $\text{V}\sim$ ”.
3. Connect the test leads across with the object to be measured.

#### Caution

- 1) Refer to “DC Voltage Caution” 1, 2, 4 .
- 2) “” means never exceed the maximum input limit 750V, otherwise internal circuit of the Meter will be damaged.

### C-3 Measuring DC Current

1. Connect the black test lead to “**COM**” jack.  
When measuring 200mA (UT51 is 2A) or below, connect the red test lead to mA jack. When measuring 20A (10A) or below, connect the red test lead to “**A**” jack.
2. Set the rotary switch to **A $\overline{\text{---}}$**  ”
3. Connect the test leads in series with the object to be measured, the LCD display the measuring value and polarity of red test lead.

#### **Caution**

- 1) If magnitude of the current is unknown, always start with the highest range and reduce until satisfactory reading is obtained.
- 2) If “**1**” is shown on the LCD, which means the Meter is overloaded, then set the measuring range to higher.
- 3) “ ” means never exceed the maximum input limit 200mV ( UT51 is 2A), otherwise will cause the burn of fuse. 20A range does not have fuse protection while UT51 at 10A range has.

### C-4 Measuring AC Current

1. Connect the black test lead to “**COM**” jack.  
When measuring 200mA (UT51 is 2A) or below, connect the red test lead to mA jack. When measuring 20A (10A), connect the red test lead to “**A**” jack.
2. Set the rotary switch to “**A~**” .
3. Connect the test leads in series with the object to be measured.

#### **Caution**

- 1) Please refer to DC Current Caution 1, 2, 3.

## C-5 Measuring Resistance

1. Connect the black test lead to “COM” jack and red test lead “ $\Omega$ ” jack.
2. Set rotary switch to “ $\Omega$ ” .
3. Connect the test leads across with the object to be measured.

### Caution

- 1) If “1” is shown on the LCD, which means the Meter is overloaded, then set a higher measuring range. If resistance is above  $1M\Omega$ , the reading will only be steady after few seconds which is normal for measuring high value of resistance.
- 2) “1” is displayed when open circuit or no input.
- 3) Make sure all objects, circuit and components to be measured are without voltage.
- 4)  $200M\Omega$  short circuit has 10 digits which need to be deducted after the reading when making measurement. For example, when measuring  $100M\Omega$  , it displays 101.0, 10 digits need to be deducted.

## C-6 Measuring Capacitance

Before measuring capacitance, remember it takes time for zeroing when changing ranges. Floating reading does not effect accuracy.

- 1) To avoid damage of the Meter or the equipment under testing, disconnect circuit powers and discharge capacitors before measuring capacitance.
- 2) Connect capacitor to the capacitance jack.
- 3) Stabilizing reading takes some time when measuring high capacitance.
- 4) Unit:  $1pF=10^{-6}\mu F$ ,  $1nF = 10^{-3}\mu F$

## C-7 Measuring Frequency

1. Connect red test lead to “Hz” jack and black test lead to “COM” jack.
2. Set the rotary switch to “kHz” .
3. Connect the test leads across with the object being measured. LCD appears the measuring value.

## C-8 Measuring Temperature

Connect one end of the bread temperature probe to the Meter and the other end to top or inside of the object being measured. LCD displays the measuring value with unit as °C .

## C-9 Measuring Diode and Continuity beeper

1. Connect the black test lead to “COM” jack and red test lead to “V” jack.
2. Set the rotary switch to “”
3. Connect the test lead across with the object being measured. LCD appears the measuring value.
4. Connect the test lead to two ends of the object being measured, the beeper sounds if the resistant value between the two ends is less than  $70\Omega$  .

## C-10 Measuring Transistor hFE

1. Set rotary switch to hFE.
2. Identify NPN or PNP, connect objects to the correspondent transistor jack.
3. LCD displays measuring value.
4. Measuring condition:  
 $I_b \approx 10\mu A$ ,  $V_{ce} \approx 2.8V$

### **C-11 Auto-Power Off function(Only for 53 54 55)**

1. The Meter equips with auto-power off function. It will be in a sleep condition once it has worked abt 15 minutes which only consume 7 $\mu$ A current during that time.
2. Press the on/off switch two times to power up again.

### **D. Maintenance**

#### **I. General Service**

The Meter is a highly precise electrical testing instrument, do not attempt to change the circuit of your Meter on your own. Take a note of the following few points:

1. Do not input to DC Voltage above 1000V or AC above 750V RMS.
2. Do not input Voltage when the rotary switch is in “**Current Range**”, “ $\Omega$ ”, “ $\rightarrow$ ” and “ $\cdot$ ”.
3. Do not operate the Meter if battery is not inside the Meter or bottom cabinet is not securely screwed.
4. Disconnect the test leads and power off the Meter before replacing the Battery and Fuses.

#### **II. Replacing the Battery**

##### **⚠ Caution**

**To avoid false readings, which could lead to possible electric shock or personal injury, replace the battery as soon as the battery indicator appears.**

To replace battery:

1. Disconnect the connection between the testing leads and the circuit under test, and remove the testing leads away from the input terminals of the Meter.

2. Turn the Meter power OFF
3. Remove the holster from the Meter.
4. Remove rubber feet and screws from the case bottom, and separate the case bottom from the case top.
5. Remove the battery from the battery compartment.
6. Replace the battery with a new 9V battery (NEDA 1604 or 6F22 or 006P).
7. Rejoin the case bottom and case top, and install the screws and rubber feet.

### III.Replacing the Fuses

#### Caution

**To avoid electrical shock or arc blast, or personal injury or damage to the Meter, use specified fuses ONLY in accordance with the following procedure.**

To replace the Meter's fuse:

1. Disconnect the connection between the testing leads and the circuit under test, and remove the testing leads away from the input terminals of the Meter.
2. Turn the Meter power OFF.
3. Remove the rubber feet and screws from the case bottom, and separate the case bottom from the case top.
4. Remove the fuse by gently prying one end loose, and then take out the fuse from its bracket.
5. Install ONLY replacement fuses with the identical type and specification as follows and make sure the fuse is fixed firmly in the bracket.  
**UT51:** 2A, 250V fast acting fuse,  $\phi$ 5x20mm (below 2A range)  
10A, 250V fast acting fuse,  $\phi$ 5x20mm (at 10A range)



**UT52/53/54/55:** 315mA, 250V fast acting fuse,  
 $\phi$  5x20mm

6. Rejoin the case bottom and the case top, and install the screw and rubber feet  
Replacement of fuses is seldom required.  
Burning of a fuse always results from the improper operation.

### E. Accessories

1. A book of users manual
2. A pair of test lead
3. A pair of WRN-01B bread temperature probe (for UT53 and UT55 ONLY)
4. A piece of holster (if selected)

### F. Using Holster

Three different ways to use holster:

1. Set holster parallel on the table, do not open the tilt stand (see diagram 1).
2. Set holster in a small angle on the table, tilt it up by the first part of tilt stand (see diagram 2)
3. Set holster in a large angle on the table, tilt it up by all two parts of tilt stand (see diagram 3).

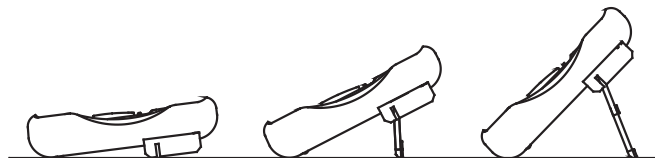

figure1

figure2

figure3

## G. Using Strap

1. Put the front end of the strap through the round metal of the Meter, see part 1 of the below diagram.
2. Put the bottom end of the strap through the front part and tie it up, see part 2 of the below diagram.

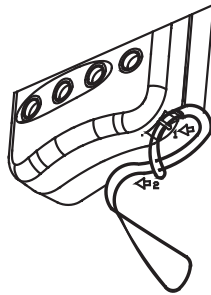

~ END ~

\* The manual is subject to changes without separate notice. \*

**UNI-T**<sup>®</sup>

**Model UT51-55: OPERATING MANUAL**

The logo for UNI-T, featuring the letters 'UNI-T' in a bold, sans-serif font with a registered trademark symbol (®) to the right. The logo is white and is set against a dark gray rectangular background.

**Model UT51-55: OPERATING MANUAL**

Manufacturer: UNI-TREND TECHNOLOGY(DONG GUAN)LIMITED

Address: Dong Fang Da Dao, Bei Shan Dong Fang Industrial  
Development District, Hu Men Town, Dong Guan City,  
Guang Dong Province, China

Headquarters: Uni-Trend International Limited

Address: Rm901, 9/F, Nanyang Plaza 57 Hung To Road  
Kwun Tong Kowloon, Hong Kong

Tel: (852) 2950 9168

Fax: (852) 2950 9303

Email: [info@uni-trend.com](mailto:info@uni-trend.com)

<http://www.uni-trend.com>